

GRICES HYDRAULIC CYLINDERS



GRICES HYDRAULIC CYLINDERS s.r.l. – Lecco ITALY



History

Grices Hydraulic Cylinders s.r.l., is an Italian family run company founded in 1978 by Mr. Bruno Cesana. It produces top quality hydraulic cylinders for industrial, naval and mobile manufacturing.

Grices has reached an important position on the market assuring its customers functionality , security and reliability.

We manufacture a complete range of standard cylinders **ISO/DIN/CNOMO** and **Customized cylinders.**

Whatever your application, OEM or replacement , you can get the correct solution and quick delivery at a competitive price.



Specialization

- We are specialized in the manufacturing of standard cylinders in accordance with the international standards **ISO DIN CNOMO**
- We offer customized cylinder designed by ourselves or by the customer
- We propose our cylinders as interchangeable spare-parts for top makes e.g. Bosch-Rexroth, Parker, etc.
- We are distributed all over Europe



We offer

- High quality products
- Competitive prices
- On-line configurator
- Quick delivery and international distribution
- Bore up to 400 mm, stroke up to 4000 mm, pressure up to 80 MPa
- One to one technical support
- Testing on 100% of all cylinders
- Complete traceability of production and delivery
- Modern flexible equipment using an Intranet system

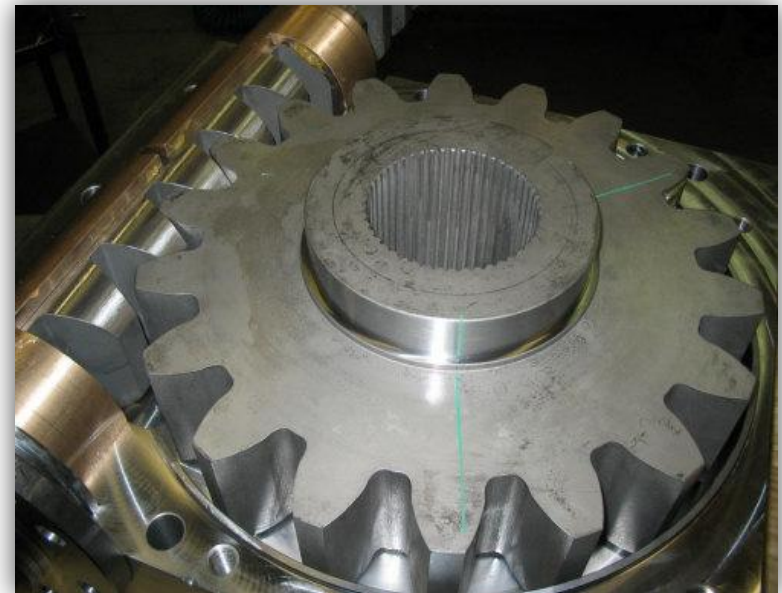

Build your cylinder with on-line configurator

Grices Hydraulic Cylinders offers an on-line configurator to help the customer choose cylinders and accessories.

Step by step guide to create a cylinder code, save it in a list, generate the *CAD 2D&3D* and *PDF* drawings, see the delivery dates, request an offer and order on-line.



On-line configurator strengths

- Shorter commission time
- User-friendly interface
- Immediate visualization of your offer
- Download 2D, 3D and PDF drawings
- Extra discount for on-line orders
- Updated technical catalogue
- Lowering of language barriers
- New partnership frontiers for distributor

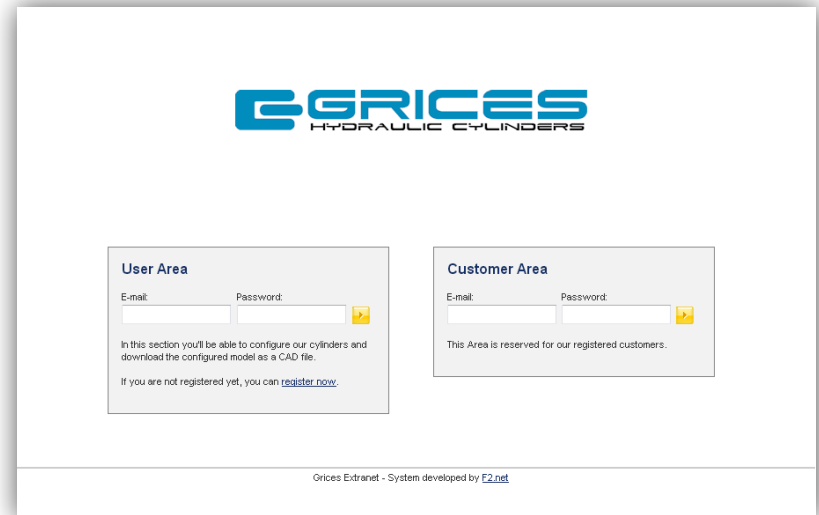

Step by step design your cylinders

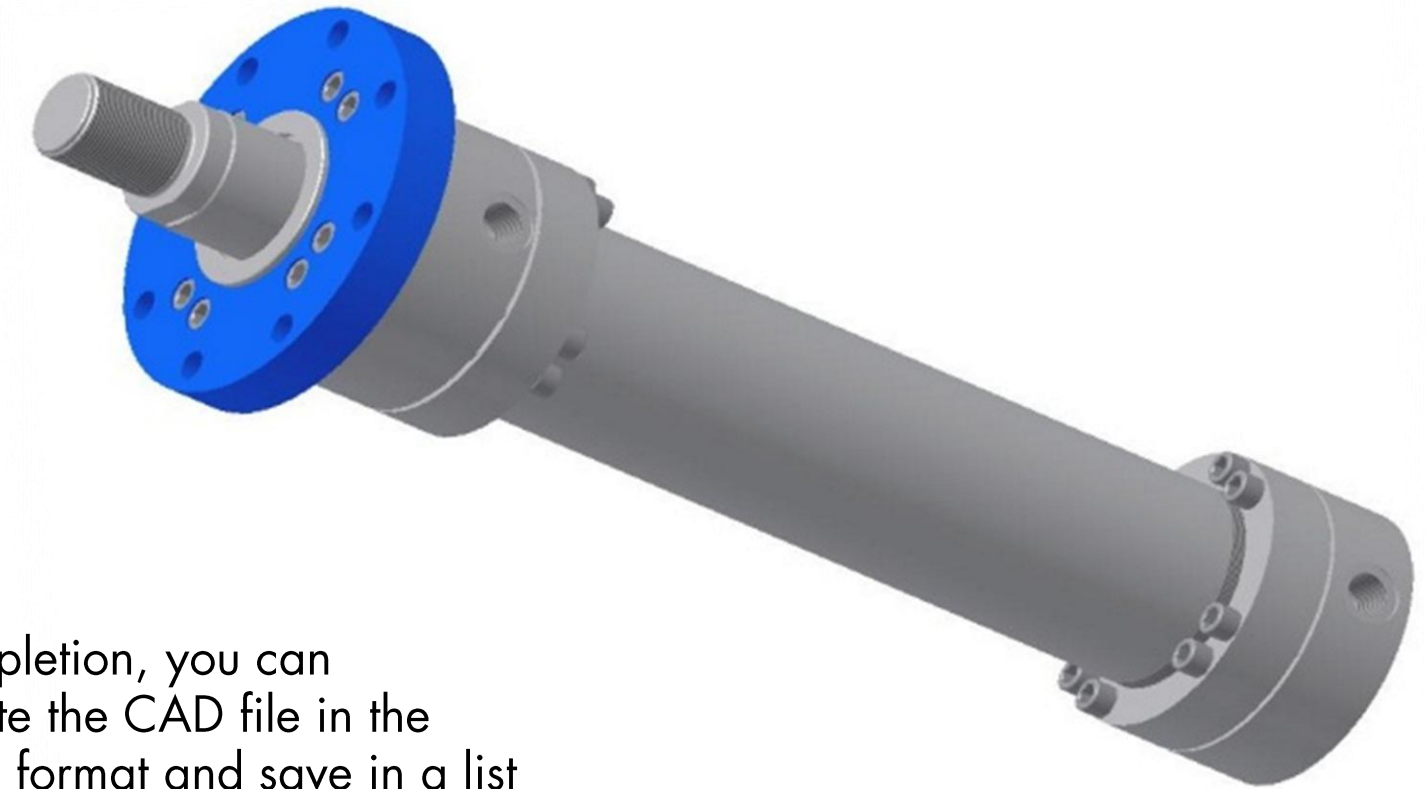

At completion, you can generate the CAD file in the desired format and save in a list relative to a project with code and quantity

Step by step design your cylinders

The program shows quantity and web discounts. The system proposes the best delivery date. By clicking on change date you may choose a new delivery date.

GRICES HYDRAULIC CYLINDERS

Company: ACME Distribution Code: 000 IP Address: 87.25.16.114
User: E-mail:

Configurator Cylinder Lists Orders Technical Catalogue Customers Log out

Cylinder Lists

ACME Distribution - Project 1 New List name Create new list Delete list

List Project 1 New name Rename New list name Copy in New List Merge to List: ACME Distributi Merge

Cylinder code	Your reference	Quantity	Weight	Delivery				Pdf
CH/25/12/0/200/FA00A000000001000R1000/0/0		2	5 Kg	15 working days				

Tot. weight: 5 Kg Delivery: 15 working days

Create a new cylinder for this list Request a quote

Grices Extranet - System developed by E2.net

Create new list or cancel existing lists. You can see the price and delivery date. By clicking send order you are brought to the e-commerce area.

GRICES HYDRAULIC CYLINDERS

Company: ACME Distribution Code: 000 IP Address: 87.25.16.114
User: prova marco E-mail: marccesana@live.it

Configurator Cylinder Lists Orders Technical Catalogue Customers Log out

Order confirmation

Order n. 1 date 23/03/2013

INVOICE AND PAYMENT

ACME Distribution
Bond Street, 35
28056 Bondyver (BY)
C.F. 00900000000 - VAT ID 00000000000

Payment:
Da concordare

ORDERED GOODS

By clicking on the "Change date" button of each row, you may change the delivery date. The calendar for selecting the new date will appear below the table.

Description of the goods	Your ref.	Quantity	Unit Price	Amount	Delivery Date	Urgent delivery charge	Change delivery
CH/25/12/0/200/FA00A000000001000R1000/0/0		2	€ 288,22	€ 536,44	15/04/2013	€ 0,00	Change date

Total: € 536,44 Charge: € 0,00

CHARGES AND DISCOUNTS

Total amount:	€ 536,44
Urgent delivery charge:	€ 0,00
Total to be discounted:	€ 536,44
Quantity discount (0%):	€ 0,00
Web order discount (3%):	€ -16,09
GRAND TOTAL WITHOUT VAT:	€ 520,35
VAT (21%):	€ 109,27
GRAND TOTAL VAT INCLUDED:	€ 629,62

DELIVERY - Verify your transport conditions and delivery destination

Transport: Ewv Destination: ACME Distribution Bond Street, 35 28056 Bondyver (BY)

Our range of production include cylinders for

- Naval
- Aerospace
- Metallurgy
- Cut to length lines
- Injection moulding machines
- Renewable energies
- Construction
- Tooling machines
- Presses
- Automotive

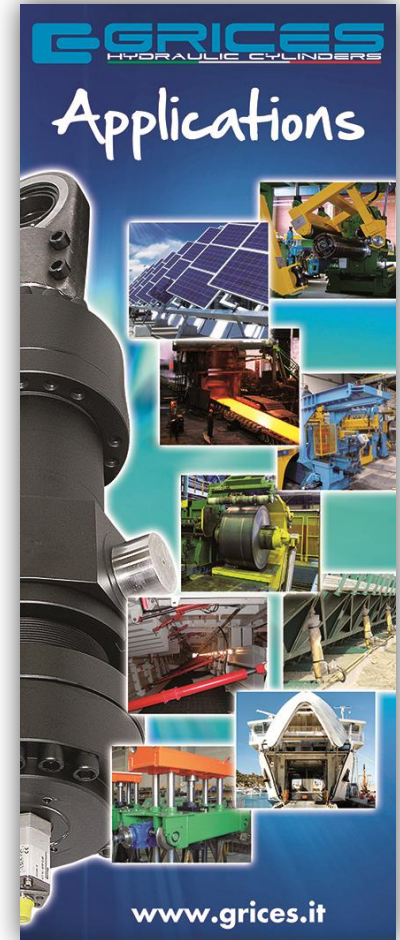

Products

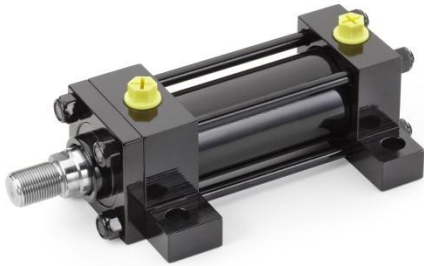

SERIES CH

ISO 6020/2 DIN 24554
NOMINAL PRESSURE 16 MPa
MAX PRESSURE 25 MPa
BORE 25 – 200



SERIES CHT

ISO 6020/2 DIN 24554
WITH LINEAR POSITION TRASDUCER
NOMINAL PRESSURE 16 MPa
MAX PRESSURE 25 MPa
BORE 25 – 200



SERIES CHM

ISO 6020/2 DIN 24554
WITH ADJUSTABLE SWITCH
NOMINAL PRESSURE 12 MPa
MAX PRESSURE 16 MPa
BORE 25 – 100

Products



SERIES CA

ISO 6020/1

NOMINAL PRESSURE 16 MPa

MAX PRESSURE 25 MPa

BORE 40 – 320



SERIES CAT

ISO 6020/1

WITH LINEAR POSITION TRANSDUCER

NOMINAL PRESSURE 16 MPa

MAX PRESSURE 25 MPa

BORE 40 – 320



SERIES CC

ISO 6022

NOMINAL PRESSURE 25 MPa

MAX PRESSURE 32 MPa

BORE 50 – 320

Products



SERIES CCT

ISO 6022

WITH LINEAR POSITION TRANSDUCER

NOMINAL PRESSURE 25 MPa

MAX PRESSURE 32 MPa

BORE 50 – 320



SERIES CB

SHORT STROKE CYLINDERS WITH ADJUSTABLE SWITCHES

NOMINAL PRESSURE 16 MPa

MAX PRESSURE 25 MPa

BORE 25 – 100



SERIES CL

WELDED CYLINDERS

NOMINAL PRESSURE 14 MPa

MAX PRESSURE 21 MPa

BORE 40 – 100

Products



SERIES CE

WELDED CYLINDERS

NOMINAL PRESSURE 16 MPa

MAX PRESSURE 25 MPa

BORE 40 – 200



NAVAL CYLINDERS

SERIES MXO AISI316

SERIES MXP AISI316

SERIES COA OT58 / AISI316

SERIES COB OT58 / AISI316

Products



ACCESSORIES

ROD ENDS

TRUNNION BRACKET

FORK JOINT HINGE

BRACKETS FOR CYLINDERS

MALE HINGE

MALE BRACKETS



KIT COMPONENTS SERIES CH

STANDARD ISO 6020/2

Customized products



Production

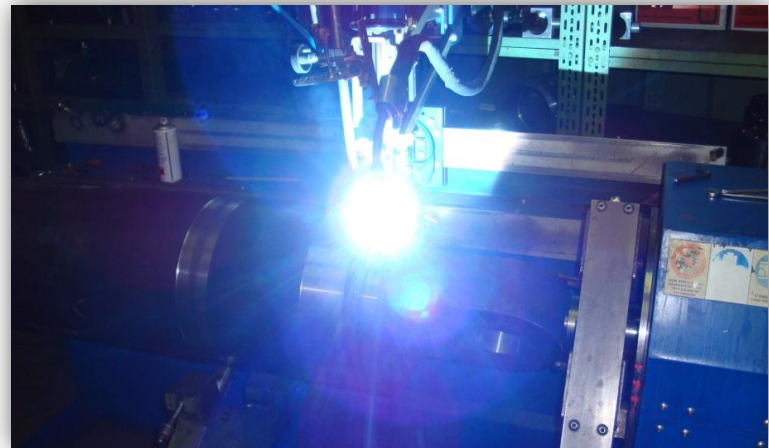

Production

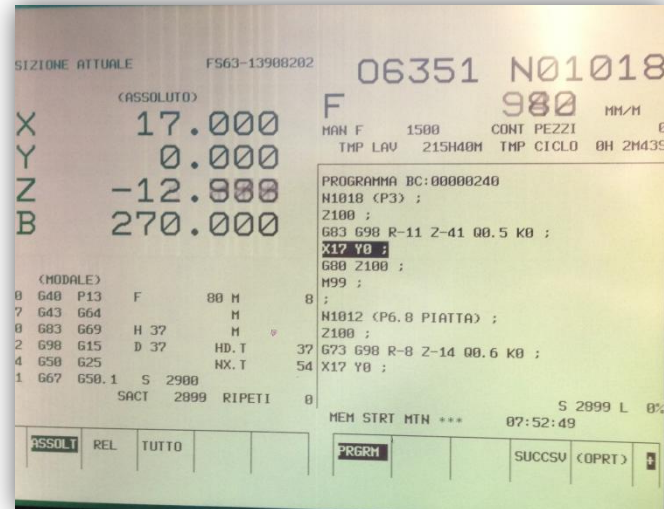

Distribution & Contact Information

Grices Hydraulic Cylinders s.r.l.

Via Postale Vecchia, 111
23857 Valgrehentino (LC) -Italy-
Phone +39 0341 660290
Fax +39 0341 660285

Sales contact:
sales@grices.it

Online configurator:
http://configuratore.grices.it/default_en.aspx

www.grices.it

